



aqaspas®

GAMA PROFESIONAL  
Overflow spas | Spas con rebosadero

SPA HOTEL I



## HOTEL I PORTABLE

|   |                    |
|---|--------------------|
| Measurements   Medidas  | ø240 x 110 cm      |
| Seats   Asientos  | 6                  |
| Massage jets   Jets de masaje   | 34                 |
| Air Jets   Jets de aire   | 12                 |
| Inox. 316 structure   Estructura inox. 316  | Standard           |
| SubLite   Luz subacuática   | Standard           |
| ChromoLite   Cromoterapia   | Standard           |
| Ozonator   Ozonizador   | Standard           |
| Thermal cover   Cubierta térmica  | Standard           |
| Titanium heater   Calentador de titanio   | 3kW                |
| Balboa® system   Sistema Balboa®  | TP600 + AX40       |
| Massage pumps   Bombas de masaje  | 2 x 2HP/CV   1.5kW |
| Air pump   Bomba de aire  | 400W               |
| Circulation pump   Bomba de circulación   | 0.35kW             |
| Compensation tank   | Incorporated       |
| Water volume   Volumen de agua  | 1600 l.            |
| Dry weight  | 420kg              |
| Filtration system with high density pressure filter or (optional) sand filter   Sistema de filtración con con filtro de alta densidad a presión o (opcional) filtro de arena. |                    |

### OPTIONS | OPCIONES

|   |
|---|
| Fusion Stereo I                                       |
| Balboa® WiFi  |
| Heat pump   Bomba de calor 0.64kW input/3.45kW output |
| Automatic drainage   Drenaje automático               |



## HOTEL I IN GROUND

|  |               |
|--|---------------|
| Measurements   Medidas                     | ø240 x 110 cm |
| Seats   Asientos                           | 6             |
| Massage jets   Jets de masaje              | 34            |
| Air Jets   Jets de aire                    | 12            |
| Inox. 316 structure   Estructura inox. 316 | Standard      |
| SubLite   Luz subacuática                  | Standard      |
| ChromoLite   Cromoterapia                  | Standard      |
| Ozonator   Ozonizador                      | Standard      |
| Thermal cover   Cubierta térmica           | Standard      |

### EQUIPMENT MODULE | MÓDULO CON EQUIPAMIENTO

|   |                    |
|---|--------------------|
| Titanium heater   Calentador de titanio | 3kW                |
| Balboa® system   Sistema Balboa®        | TP600 + AX40       |
| Massage pumps   Bombas de masaje        | 2 x 2HP/CV   1.5kW |
| Air pump   Bomba de aire                | 400W               |
| Circulation pump   Bomba de circulación | 0.35kW             |
| Filtration system                       | Sand Arena         |

### OPTIONS | OPCIONES

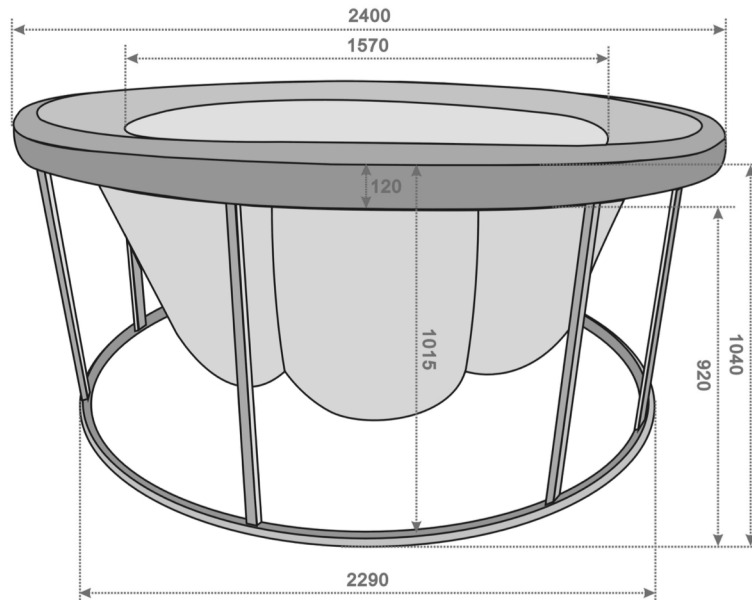
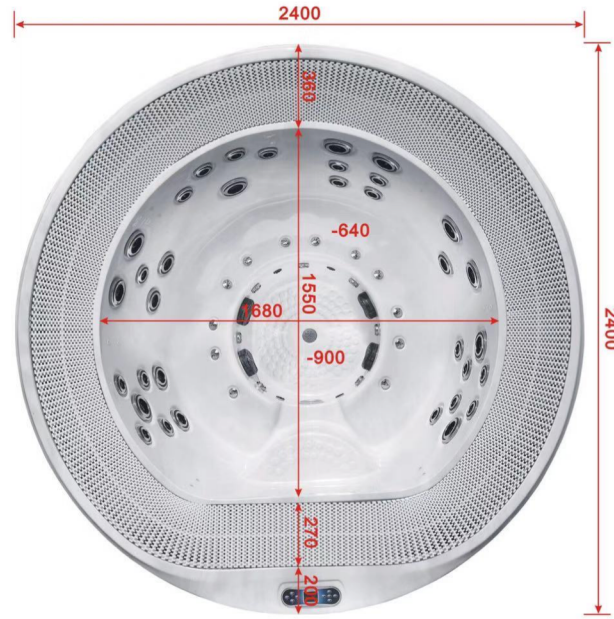

|   |
|---|
| Tanque de compensación   Compensation tank            |
| Caja eléctrica   Electrical box                       |
| Balboa® WiFi  |
| Heat pump   Bomba de calor 0.64kW input/3.45kW output |
| Equipamiento de regulador de Cl & pH   Cl & pH Feeder |
| Automatic drainage   Drenaje automático               |

# MEASUREMENTS | MEDIDAS

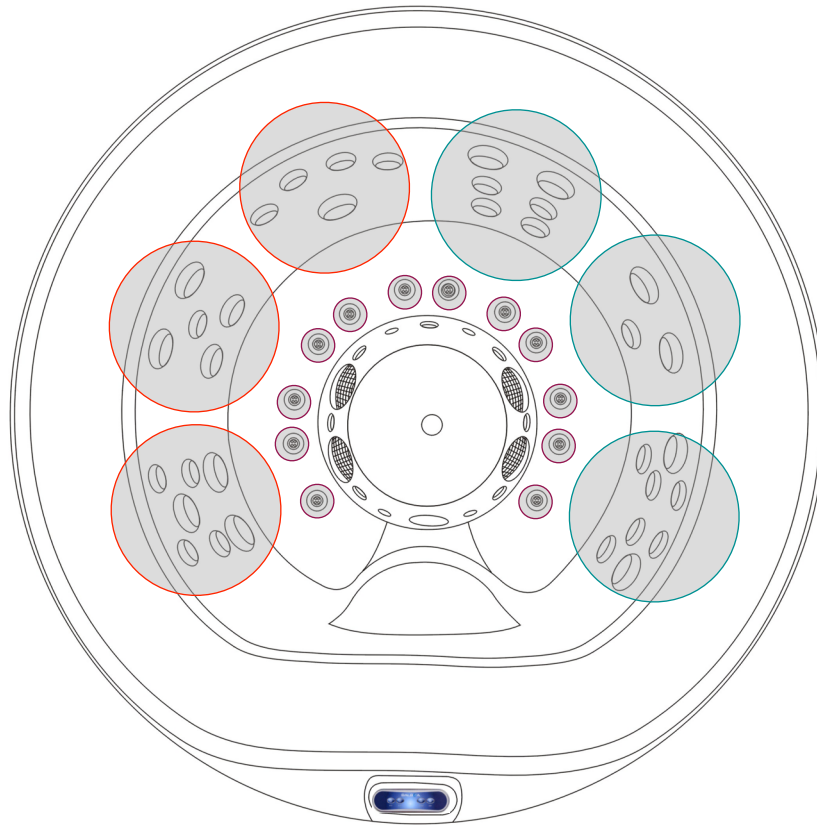

# Water & AIR | Agua & Aire



-  Massage pump 1 | Bomba de masaje 1
-  Massage pump 2 | Bomba de masaje 2
-  Air jets | Jets de aire



Lights | Luces

Air | Aire

Pump 2 | Bomba 2

Pump 1 | Bomba 1

# Chromotherapy | Cromoterapia

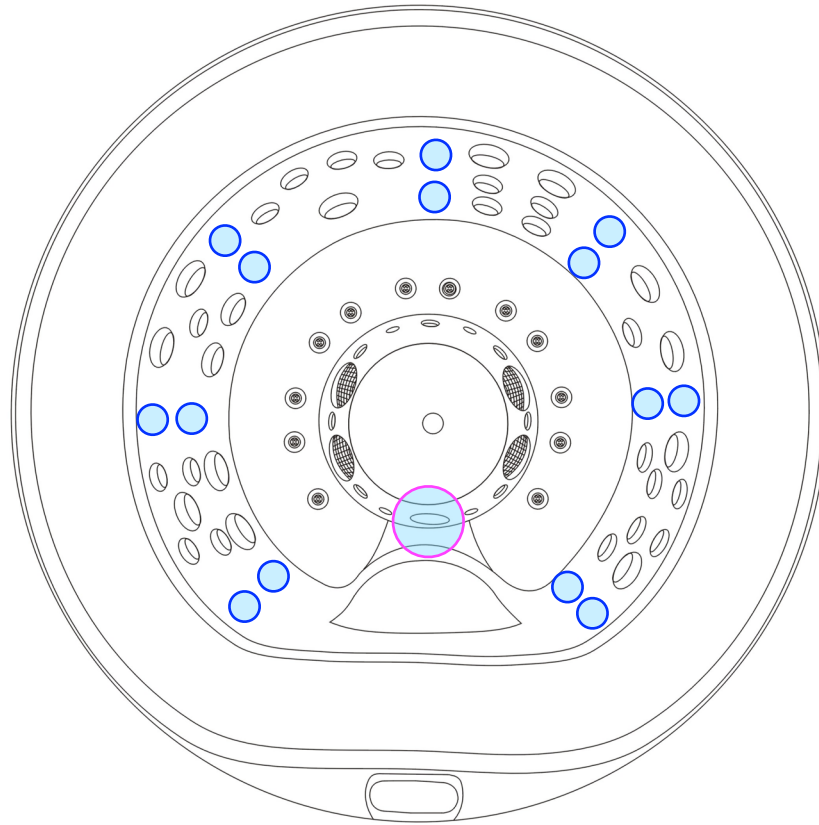

● LEDs x 14

● SubLite x 1

# COMPONENTS | COMPONENTES (Portable)

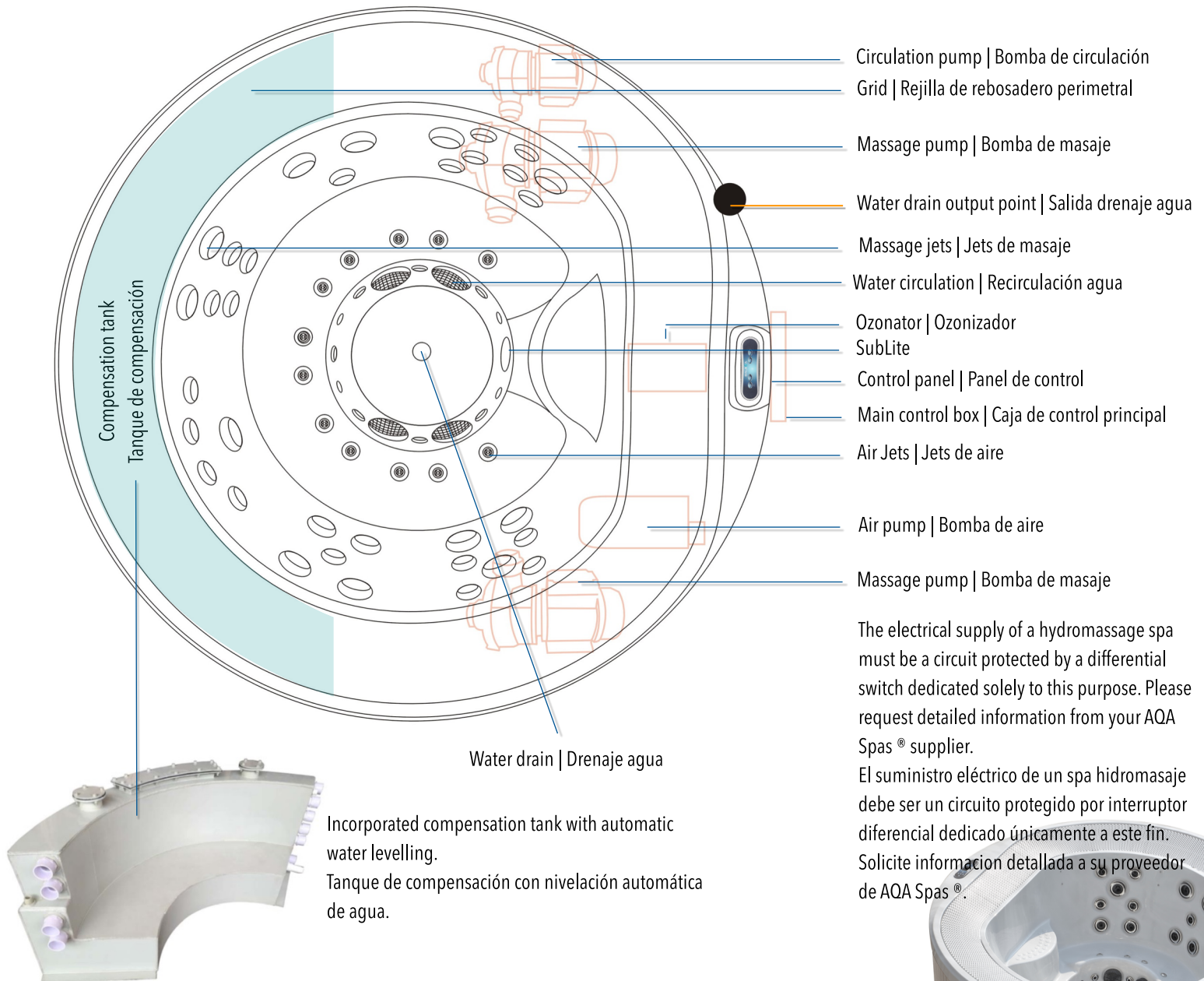

The electrical supply of a hydromassage spa must be a circuit protected by a differential switch dedicated solely to this purpose. Please request detailed information from your AQA Spas® supplier.

El suministro eléctrico de un spa hidromasaje debe ser un circuito protegido por interruptor diferencial dedicado únicamente a este fin. Solicite información detallada a su proveedor de AQA Spas®.



# MODULE | MÓDULO (Hotel I In Ground)

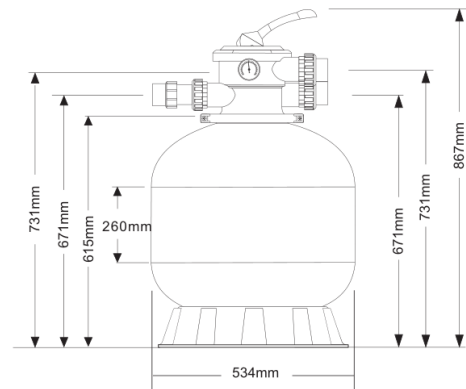
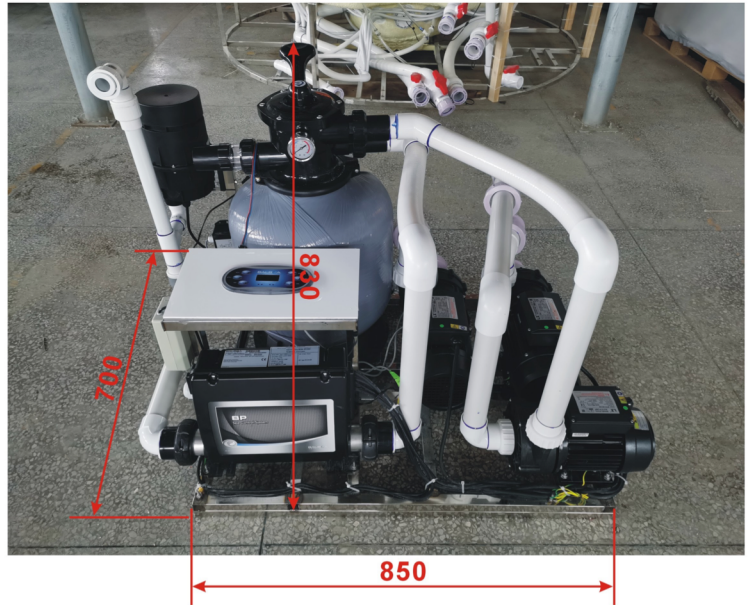
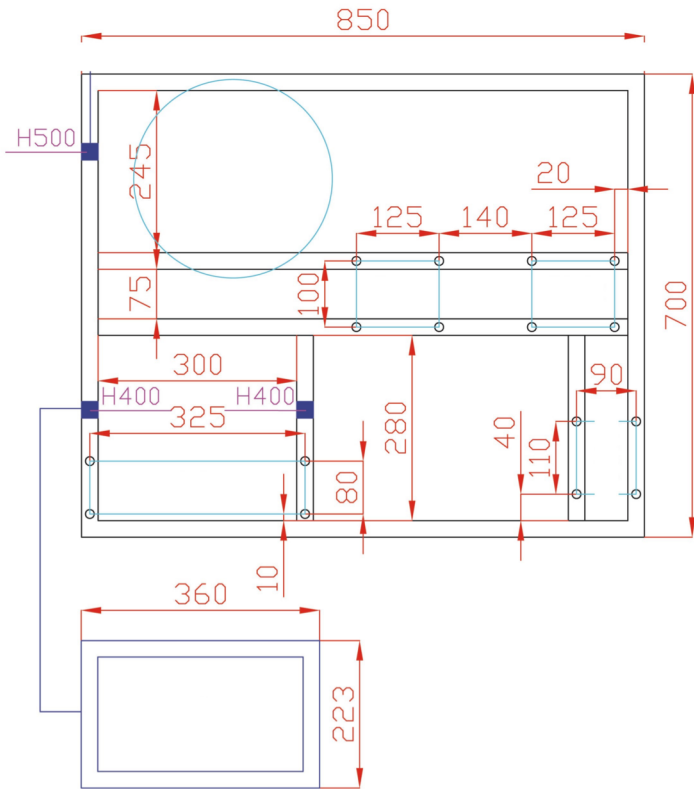

# WATERCARE



## CRYSTAL CLEAN AND CLEAR WATER

All our spas and swimspas are equipped with an ozonator. We always supply water maintenance instructions with your spa, where we recommend the use of additional water care products. For spas for public use, **we recommend the installation of an automatic cl/pH feeding system.**

## OZONATOR

An ozonator injects ozone (O<sub>3</sub>) to the tubery system of the spa, it disinfects the water, and quickly turns into normal oxygen. A 100% natural way to clean the water of your spa which additionally removes oils and lotions.

## AGUA CRISTALINA Y LIMPIA

Todos nuestros spas y swimspas están equipados con un ozonizador. Siempre suministramos instrucciones de mantenimiento de agua con su spa, donde recomendamos el uso de productos adicionales para el cuidado del agua. **Para spas de uso público, recomendamos la instalación de un sistema automático de alimentación de Cl/pH.**

## OZONIZADOR

Un ozonizador inyecta ozono (O<sub>3</sub>) al sistema de tuberías del spa, desinfecta el agua y se convierte rápidamente en oxígeno normal. Una forma 100% natural de limpiar el agua de su spa que además elimina aceites y lociones.







A DIFFERENT MASSAGE IN EACH SEAT | UN MASAJE DIFERENTE EN CADA ASIENTO

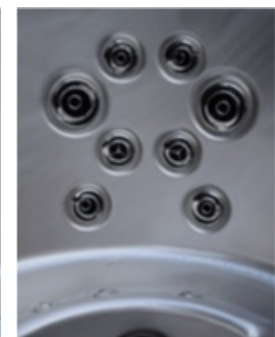

# COLOURS

## PANELS PanPlus



Woven Espresso



Dark Woven Grey



Black

## COVER CoverChoice



Brown



Espresso

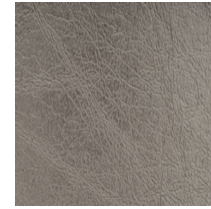

Light Grey

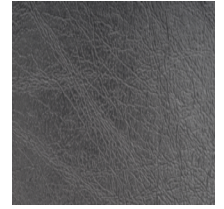

Dark Grey

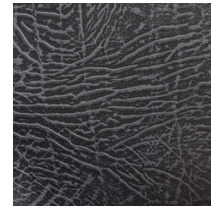

Woven Grey

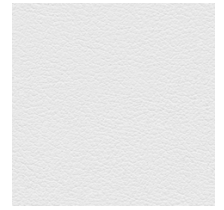

White



Pure White



Gypsum



White Silver Marble



**aqaspas**<sup>®</sup>  
www.aqaspas.com

OUR TEAM AT AQA SPAS IS INTERNATIONAL. WE SPEAK ENGLISH. WIJ SPREKEN NEDERLANDS.  
WIR SPRECHEN DEUTSCH. VI PRATAR SVENSKA. ON PARLE FRANÇAIS. МЫ ГОВОРИМ ЛО-РУССКИ.

®

Specifications in this catalogue may be subject to change. © aqa spas<sup>®</sup> 2020. aqa spas is a registered trade mark.